

MIXER AIRTECH STANDARD powder conveying group - Type 140 RIETSCHLE - General view

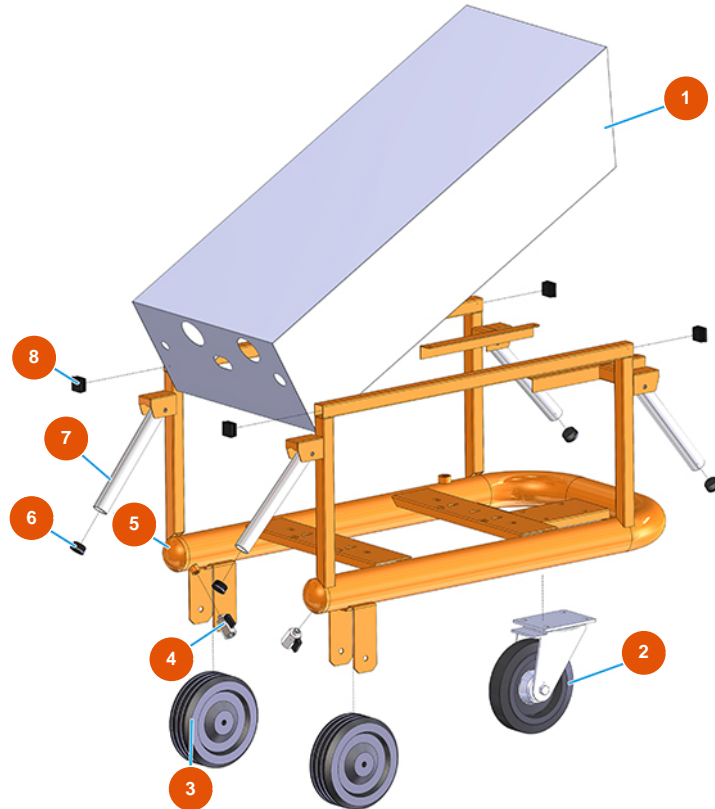

Détails des pièces

Pos.	Référence	Désignation
1	402500050A	1
2	3F00300901	Wheel Ø 200/70 revolving plate w/brake
3	3F00300603	Supportless wheel Ø 200
4	3G01200102	Tap MINIBALL M/F 1/4"
5	701301950A	5
6	3F00400400	PVC black top D.32
7	4914001000	Front lifting handle galv. PLUS
8	3F00400203	Black top 30x30

MIXER AIRTECH STANDARD powder conveying group - Type 140 RIETSCHLE - Compressor

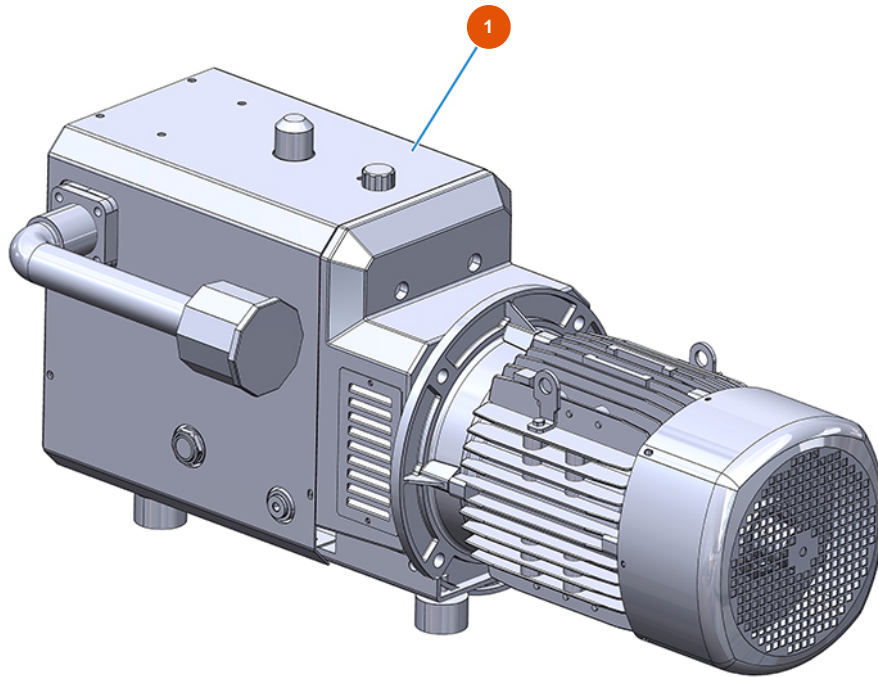

Détails des pièces

Pos.	Référence	Désignation
1	3B01611000	Rietschle compressor DLR 120

MIXER AIRTECH STANDARD powder conveying group - Type 140 RIETSCHLE - Air group - A

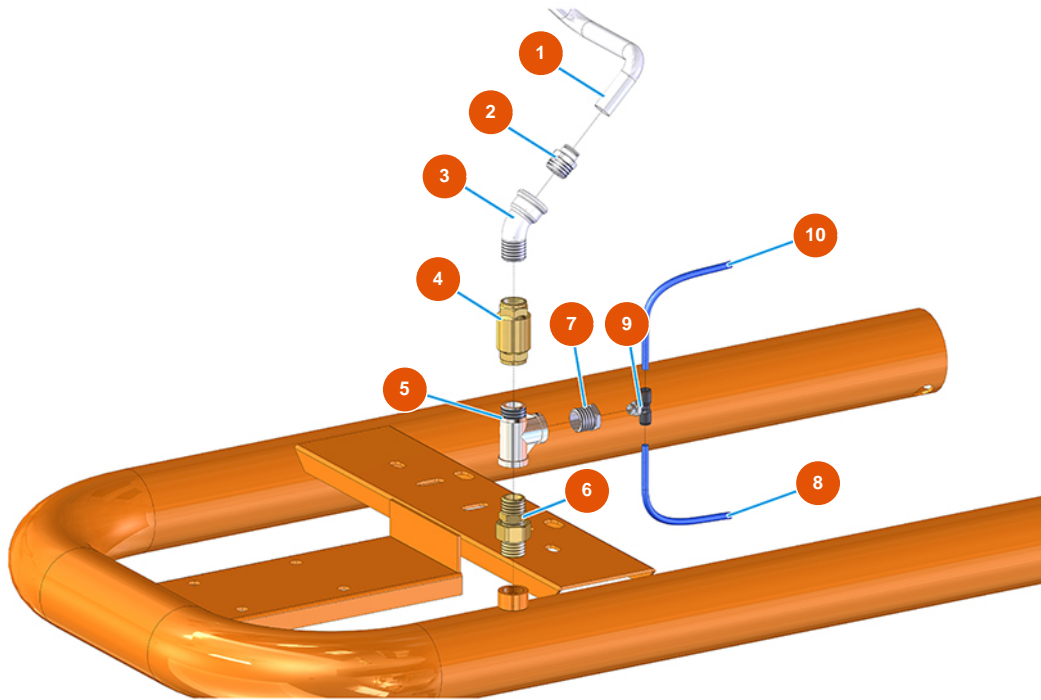

Détails des pièces

Pos.	Référence	Désignation
1	3G50500200	Hose 12X14 RILSAN
2	3G50200101	Legris joint straight 1/2X14 3175
3	3G00504001	Elbow join galvanized 45° MF FIG.40 1/2"
4	3G01300402	Check valve EUROPA 1/2"
5	3G00513402	T-joint FFM galvanized FIG.134 1/2
6	3G50301201	3-pieces connector M-M OR 1/2-1/2 FIG.7
7	3G50300100	Steel reduction 1/2X1/4
8	3G50500100	Hose ELASTOLLAN 6X4
9	3G50200302	Legris central T - joint 1/8M
10	3G50500100	Hose ELASTOLLAN 6X4

MIXER AIRTECH STANDARD powder conveying group - Type 140 RIETSCHLE - Air group - B

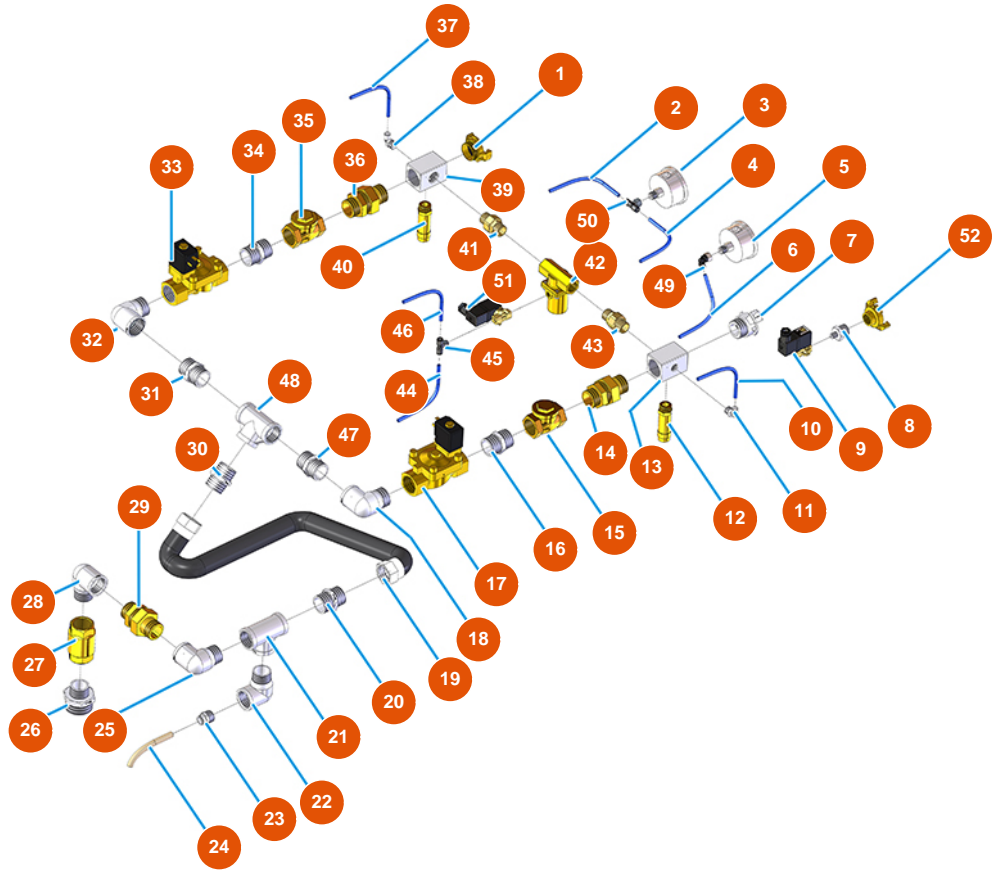

Détails des pièces

Pos.	Référence	Désignation
1	3A00100304	Male Geka coupling 1"
2	3G50500100	Hose ELASTOLLAN 6X4
3	3G00100140	Axial manometer 0-4 bar
4	3G50500100	Hose ELASTOLLAN 6X4
5	3G00100140	Axial manometer 0-4 bar
6	3G50500100	Hose ELASTOLLAN 6X4
7	3A00400105	EXPRESS connenctor M. 1
8	3G50300100	Steel reduction 1/2X1/4
9	3G01301106	Pilot for pneum. valve
10	3G50500200	Hose 12X14 RILSAN
11	3G50200200	Legris coupling elbow joint 6X1/4
12	3G01300306	Safety valve 1/2" calibrated 5 BAR

Pos.	Référence	Désignation
13	3G50301003	Joint for AIRTECH 2009
14	3G01700308	3-pieces connector M-F 3/4
15	3G01300803	CLAPET valve 3/4"
16	3G00528002	Galvanized nipple FIG.280 1/2
17	3G00300152	Electrovalve 1" M&M
18	3G00509204	Elbow join galvanized 90° MF FIG.92 1"
19	8002008003	Radiator hose SPL D.25X35 L=650 with coupling
20	3G00528002	Galvanized nipple FIG.280 1/2
21	3G00513004	T-joint FFF galvanized FIG.130 1
22	3G00509204	Elbow join galvanized 90° MF FIG.92 1"
23	3G50200101	Legris joint straight 1/2X14 3175
24	3G50500200	Hose 12X14 RILSAN
25	3G00509206	Elbow join galvanized 90° MF FIG.92 1"1/2
26	3G00524106	Galvanized reduction FIG.241 1 1/4X1/2
27	3G01300404	Check valve EUROPA 1"
28	3G00509204	Elbow join galvanized 90° MF FIG.92 1"
29	3G01700311	3-pieces connector M-M 1"
30	3G00528002	Galvanized nipple FIG.280 1/2
31	3G00553003	31
32	3G00509204	Elbow join galvanized 90° MF FIG.92 1"
33	3G00300152	Electrovalve 1" M&M
34	3G00528002	Galvanized nipple FIG.280 1/2
35	3G50300100	Steel reduction 1/2X1/4
36	3G01700311	3-pieces connector M-M 1"
37	3G50500100	Hose ELASTOLLAN 6X4
38	3G50200200	Legris coupling elbow joint 6X1/4
39	3G50301003	Joint for AIRTECH 2009
40	3G01300302	Safety valve 1/2" calibrated 2 BAR
41	3G01700300	3 piece connector MF (I1)
42	3G01301105	Pneum. control valve
43	3G01700300	3 piece connector MF (I1)
44	3G50500100	Hose ELASTOLLAN 6X4
45	3G50200300	Legris T - joint MFF 1/4
46	3G50500100	Hose ELASTOLLAN 6X4

Pos.	Référence	Désignation
47	3G00528002	Galvanized nipple FIG.280 1/2
48	3G00513402	T-joint FFM galvanized FIG.134 1/2
49	3G50200200	Legris coupling elbow joint 6X1/4
50	3G50200300	Legris T - joint MFF 1/4
51	3G01300702	3-ways solenoid valve 1/4 M&M
52	3A00100202	Female Geka coupling 1/2"

MIXER AIRTECH STANDARD powder conveying group - Type 140 RIETSCHLE - Electric panel

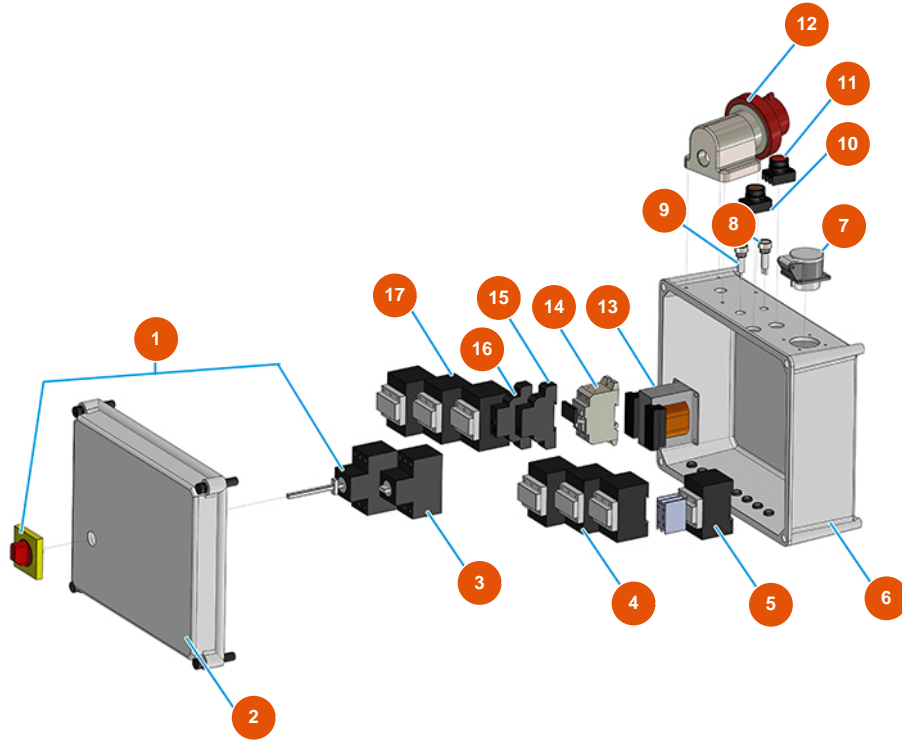

Détails des pièces

Pos.	Référence	Désignation
1	3C04400207	Complete phase inverter PLUS STANDARD
2	3C00110158	2
3	3C01030108	ABB-MS325 20A magnetic
4	3C00700117	Counter 4 KW 24V AC SIEMENS
5	3C00700103	Tripolar counter 4KW 42VAC 1NC
6	3C00110457	6
7	3C02600100	2-pin + ground 16A / 42V female inclined plug
8	3C04000106	Orange light indicator with cable 24V
9	3C04000109	White light indicator with cable 24V
10	3C04000105	Green button D.22
11	3C04000104	Red button D.22
12	3C03000305	3-pin + neutral + ground 32A surface-mount male plug



Pos.	Référence	Désignation
13	3C00500402	Transformer 70/80VA 400/42/24/15
14	3C05050501	Fuse holder bipolar 10,3X38
15	3C00601001	Cycle sense phase relay
16	3C03750400	Timer 2 delayed threads 24/230AC/DC
17	3C00700120	Counter 11 KW 24VAC 1NC +1NO

MIXER AIRTECH STANDARD powder conveying group - Type 140 RIETSCHLE - Conveyor group

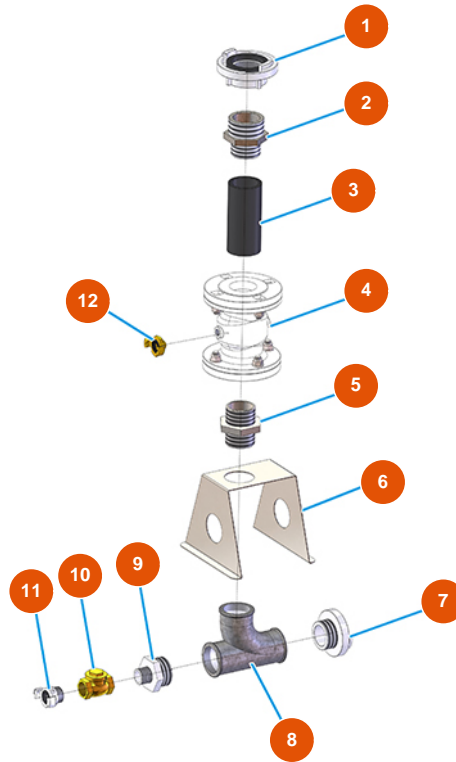

Détails des pièces

Pos.	Référence	Désignation
1	3A00200101	Female STORZ coupling 2"1/2
2	3G00524508	Galvanized reduced nipple FIG.245 2 1/2X2
3	3G01310001	Hose val. Ø 70 L=150 x conveyor group
4	3G01310000	Conveyor valve
5	3G00528007	Nipple galvanized FIG.280 2"
6	4013010100	6
7	3A00200301	Male STORZ coupling 2"
8	3G00513101	T-joint w/1 bow 131 2" galvanized
9	3G00524507	Galvanized reduced nipple FIG.245 2X1
10	3G01300801	Valve CLAPET 1"
11	3A00400105	EXPRESS connenctor M. 1
12	3A00100301	Male Geka coupling 3/8"