

MIXER AIRTECH STANDARD powder conveying group - Type 140 - General view

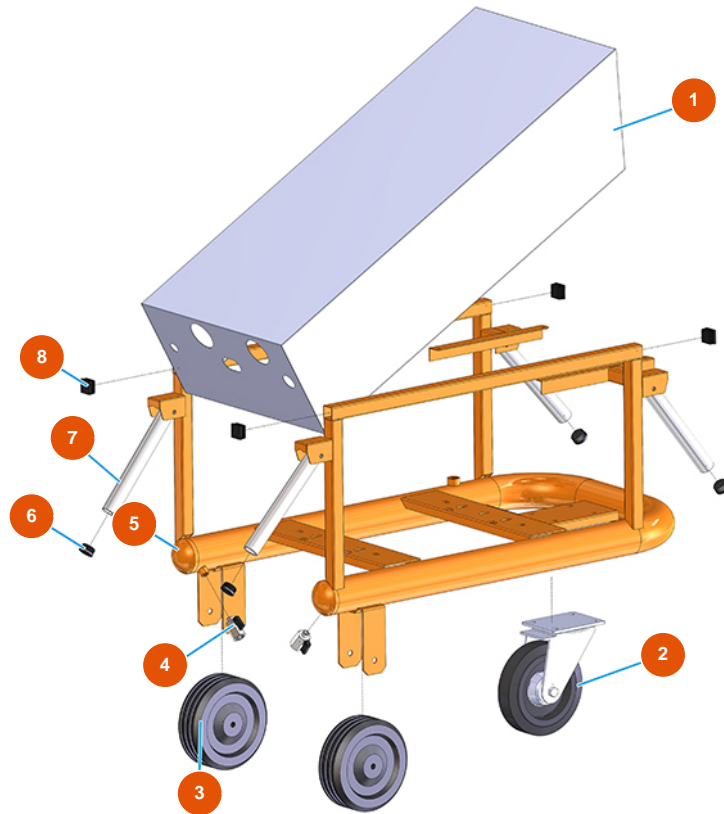

Détails des pièces

Pos.	Référence	Désignation
1	402500050A	1
2	3F00300901	Wheel Ø 200/70 revolving plate w/brake
3	3F00300603	Supportless wheel Ø 200
4	3G01200102	Tap MINIBALL M/F 1/4"
5	701301950A	5
6	3F00400400	PVC black top D.32
7	4914001000	Front lifting handle galv. PLUS
8	3F00400203	Black top 30x30