

## OPTIMIX 20 spraying machine - 5,5 kW - General view

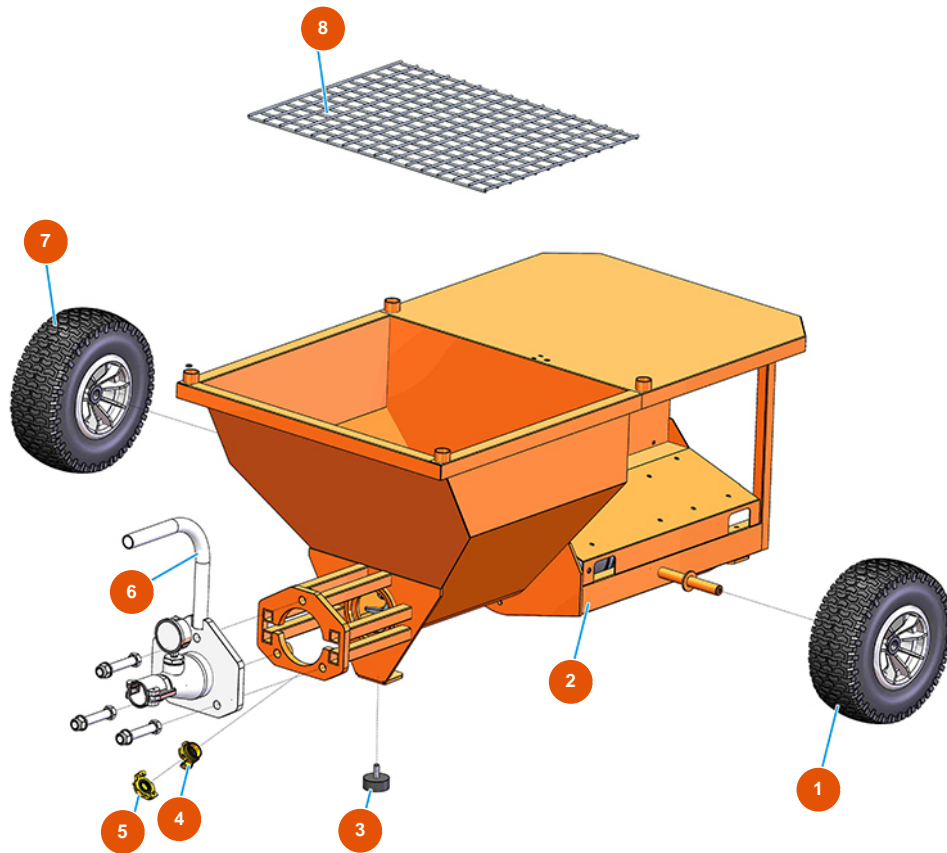

### Détails des pièces

Pos.	Référence	Désignation
1	3F00301109	Inflatable wheel 13 X 5.00
2	701202400A	2
3	3T00200309	Anti-vibration foot 50X20M10X2
4	3A00100204	Female Geka coupling 1"
5	3A00100401	Geka plug
6	8012007000	Pump flange with pressure meter for OPTIMIX 20
7	3F00301109	Inflatable wheel 13 X 5.00
8	4029000800	Grid for OPTIMIX 20