

OPTIMIX 20 spraying machine - 5,5 kW - Sieve

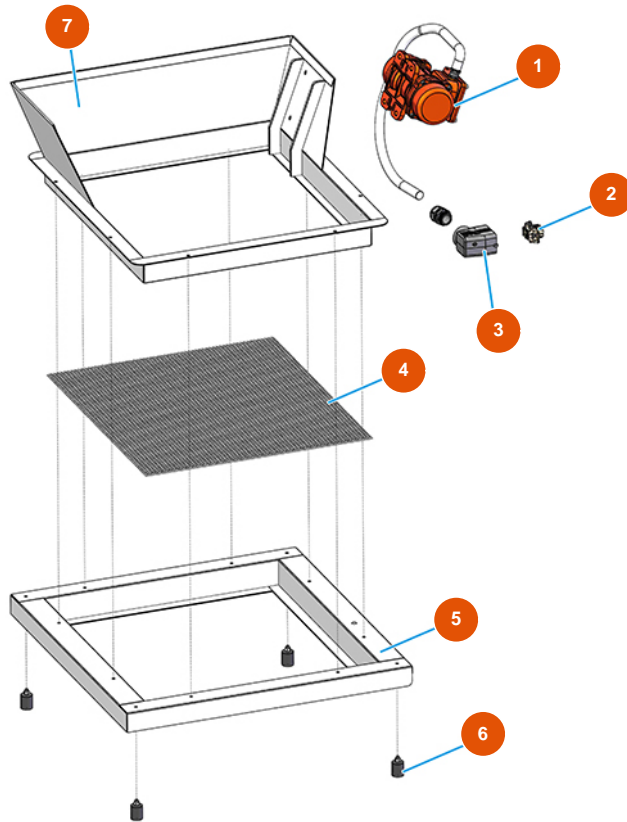

Détails des pièces

Pos.	Référence	Désignation
1	3D00500401	Vibrating motor MVE100/3M 230
2	3C03100500	6-pin 16A male insert
3	3C02800104	L16 cover one closure
4	4919018200	Net wire 1,5 10X10 525X585 Galv.
5	7013028000	Galvanized sieve frame 188
6	3T00200308	Anti-vibration foot 25X30 M6
7	7013023600	Chassis frame 188 galvanized